

Data sheet | Item number: 770-655

Intermediate coupler; 5-pole; Cod. A; for sockets and plugs

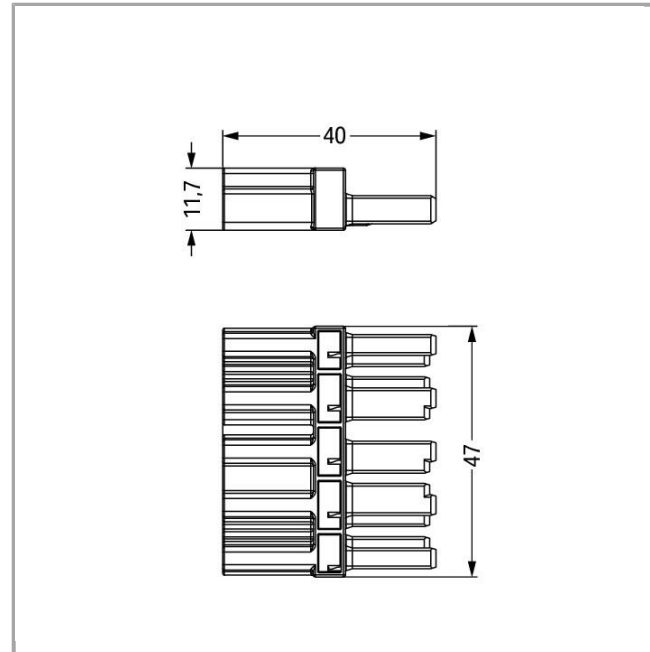

770-655



Item description

- Protected against mismatching and maintenance-free
- Push-in CAGE CLAMP® spring pressure connection technology allows solid conductors to be simply pushed into a unit
- Two-wire connection per pole for loops or bridges
- Additional variable coding is possible

Note:

All connectors for mounted installations (snap-in versions for lighting fixtures or devices, all types of PCB and distribution connectors) are factory-equipped with locking levers to ensure plugs and sockets are securely locked. Additional locking levers are only required for flying leads (plug /socket).

Safety information 1:

Application note for the U.S. market (USR): Some versions may also be used for current interruption in accordance with the UL certificate in select applications with currents below 16 A and voltages up to 600 V. For further information, please contact your local sales office.

Data

Electrical data

Note on Contact Resistance



approx. 1mΩ contact resistance

approx. 0.25mΩ contact transition plug/socket

Ratings per IEC/EN 60664-1

Rated voltage (III / 3)	400 V
Rated impulse voltage (III / 3)	6 kV
Rated current	25 A

Approvals per UL 1977

Rated voltage per UL 1977 (factory wiring only)	600 V
Rated current per UL 1977 (factory wiring only)	23 A

Connection data

No. of poles	5
Total number of potentials	5

Geometrical Data

Pin spacing	10 mm / 0.394 inch
Width	47 mm / 1.85 inch
Height	11.6 mm / 0.457 inch
Depth	40 mm / 1.575 inch

Mechanical data

Coding	A
Mating force of a plug-in connection	approx. 20 ... 70 N (depending on pole number)
Retention force of a plug-in connection	When locked: > 80 N
Unmating force of a plug-in connection	when unlocked: approx. 20 ... 70 N (depending on pole number)
Number of mating cycles	

200, without resistive load

100, with resistive load $I_N = 25A$, tested (4 mm²/AWG 12)

Type of distribution connector	Intermediate coupler
Protection class	IP20
Note on protection class	Only in mated condition (These compact connectors are not designed for use in open, easily accessible areas.)

Plug connection

Contact type (pluggable connector)	Socket/plug
Mismating protection	Yes
Locking of plug-in connection	locking lever
Locking lever	yes

Material Data

Color	white
Insulating material	Polyamide 66 (PA 66)
Flammability class per UL94	V0
Contact material	Copper or copper alloy, surface-treated
Fire load	0.174 MJ
Weight	9.584 g

Environmental Requirements

Surrounding air (operating) temperature	-35 ... 85 °C
Processing temperature	-5 ... +40 °C
Continuous operating temperature	-35 ... +85 °C
Note on Continuous Service Temperature	Insulating parts for temperatures ≤ 105 °C

Commercial data

Country of origin	DE
GTIN	4044918524209
Customs Tariff No.	85366990990

Approvals / Certificates



Country specific Approvals

Logo	Approval	Additional Approval Text	Certificate name
	CCA DEKRA Certification B.V.	EN 61535	2173495.02
	CCA DEKRA Certification B.V.	IEC 61535	NL-32105

Ship Approvals

Logo	Approval	Additional Approval Text	Certificate name
	ABS American Bureau of Shipping	-	14- HG1241528- PDA





	DNV GL Det Norske Veritas, Germanischer Lloyd	-	TAE00001Z6
	DNV GL Det Norske Veritas, Germanischer Lloyd	-	TAE00001Z6
	LR Lloyds Register	IEC 61984	02/20050 (E6)

UL-Approvals

Logo	Approval	Additional Approval Text	Certificate name
	cURus Underwriters Laboratories Inc.	UL 1977	E45171 Sec. 9

Compatible products

protection

	Item no.: 770-201 Lockout cap; 12-pole, separable; 12-pole; for sockets	770-201
	Item no.: 770-221 Lockout cap; for socket; 12-pole; separable	770-221
	Item no.: 770-360 Lockout cap; for plugs; 5-pole; separable	770-360

Downloads

Documentation

Bid Text

770-655 WINSTA MIDI 5-polig	Apr 4, 2012	doc 23.6 kB	Download
--------------------------------	-------------	----------------	----------



CAD/CAE - Smart Data

CAD data

3D Download 770-655

URL

Download

Subject to changes.
